

RP-8i

modelo

CARACTERÍSTICAS

- **4000 divisiones OIML-R60 clase C**
4000 divisions OIML-R60 class C
- **Totalmente de Acero Inoxidable**
Fully stainless steel
- **Sellado Hermético por láser**
Hermetically sealed laser welded
- **Estanqueidad IP-68 (EN60529)**
Protected against humidity IP-68 (EN60529)

inox
en acero inoxidable



CAPACIDAD: 18 Tn.. 50 Tn
Capacity

CARACTERÍSTICAS TÉCNICAS		
Carga Nominal (E _{max})	18.000.. 50.000 Kg	Rated Capacity (E _{max})
Clase de Precisión OIML R60	C4	Accuracy Class OIML R60
Sensibilidad (S _n)	2mV/V ±1%	Rated Output (S _n)
V _{min}	E _{max} /15000	V _{min}
Resistencia de Entrada	800 ± 2Ω	Input Resistance
Resistencia de Salida	700 ± 3Ω	Output Resistance
Rango de la Tensión de Aliment.	5.. 12V	Excitation Voltage Range
Tensión Máxima de Aliment.	15V	Maximum Excitation Voltage
Resistencia de Aislamiento	>5000MΩ	Insulation Resistance
Efecto de la Temp. en el Cero	< ± 0,02%Sn/5°K	Temp. Effect on Zero
Efecto de la Temp. en la Sensibil.	< ± 0,004%Sn/5°K	Temp. Effect on Sensitivity
Compensación de Temperatura	-10.. +40°C	Temperature Limits
Temperatura de Servicio	-30.. +70°C	Service Temperature Range
Error Combinado	< ± 0,017%Sn	Total Error
Fluencia (30 minutos)	< ± 0,016%Sn	Creep in 30 minutes
Balance de Cero	< ± 1,5%Sn	Cero Offset
Carga mínima	0,05%E _{max}	Minimum Dead Load
Carga de Servicio	120%E _{max}	Service Load
Carga Límite	150%E _{max}	Safe Load Limit
Carga de Rotura	>150%E _{max}	Breaking Load
Deformación Máxima a E _{max}	0,25 a 0,5 mm	Deflection at Rated Load
Grado de Protección	IP68	Protection Class
Peso aproximado	2 Kg	Weight, approx

DIMENSIONES

CAPACIDAD	R
18.000.. 20.000 Kg	130
25.000 Kg	150
30.000 Kg	160
35.000.. 40.000 Kg	180

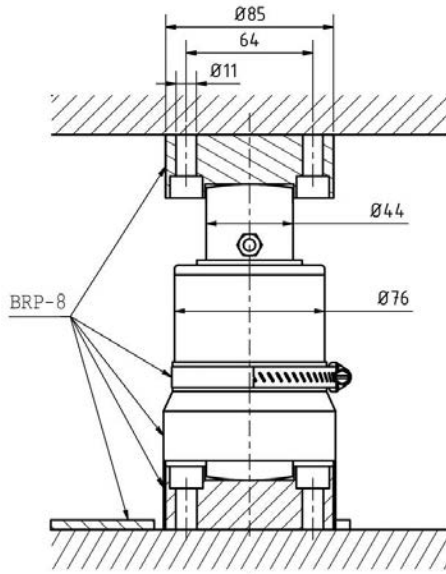

Dimensiones (mm)

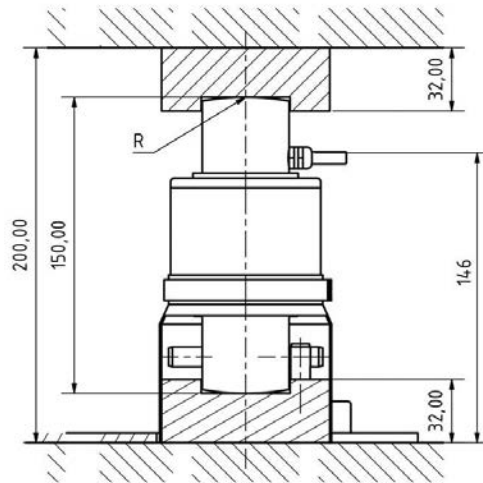

ACCESORIO BRP-8i



Juego 2 Bases

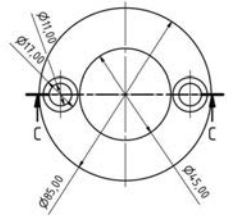
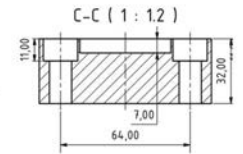
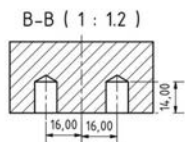
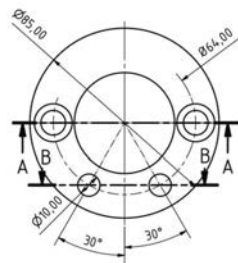
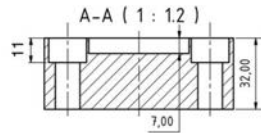

CONEXIÓN ELÉCTRICA

